

MANUAL DE MONTAJE

A3



MAMPARA ANGULAR DE DUCHA

1 HOJA CORREDERA + 2 FIJAS

A3

1

PRESENTAMOS PERFILES "U" DE FIJOS, EN PAREDES, SEGÚN CORRESPONDA SU POSICIÓN, NIVELÁNDOLO, A 3 MM. DEL BORDE DEL PLATO DE DUCHA Y MARCAMOS TALADROS.

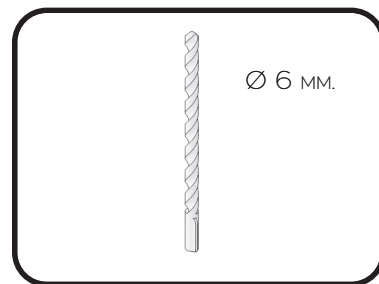
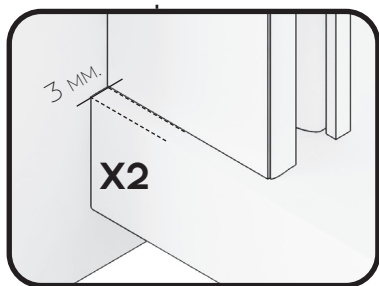

2

TALADRAR LA PARED CON BROCA DE 6MM.



3

ATORNILLAR LOS PERFILES "U" A PARED, FIJÁNDOLOS CON TACOS DEL N° 6 Y LOS 6 TORNILLOS 4.2X32.



4

COLOCAMOS GOMA DE ESTANQUEIDAD INFERIOR EN LAS HOJAS FIJAS E INTRODUCIMOS LOS VIDRIOS EN LAS "U", APOYANDOLOS SOBRE ESTA.



5

COLOCAR LA PINZA GUIA INFERIOR EN EL EXTREMO DEL VIDRIO FIJO FRONTAL, MONTANDOLA PREVIAMENTE SEGÚN CORRESPONDA SU POSICIÓN.



MONTAJE PINZA GUIA INFERIOR

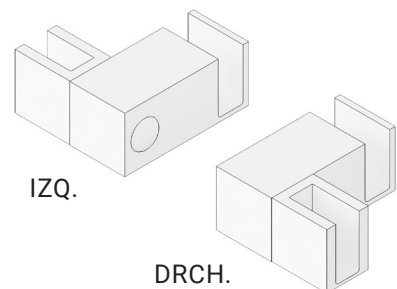
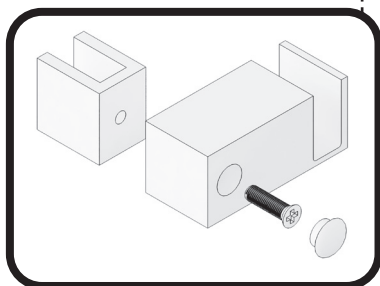

A3

6

PRESENTAR GUÍA SUPERIOR CON VASOS Y CODO UNIÓN, FIJÁNDOLO CON SUS TORNILLOS AUTOROSCANTES, SOBRE LOS VIDRIOS FIJOS, NIVELAR Y MARCAR LOS TALADROS.

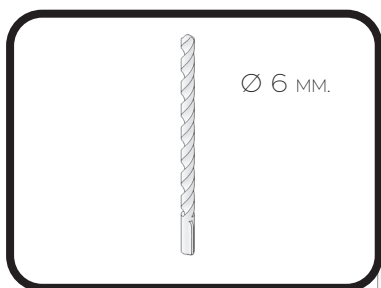
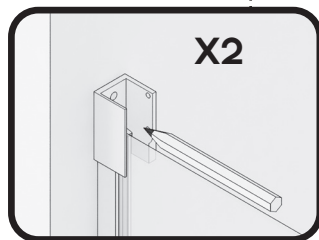
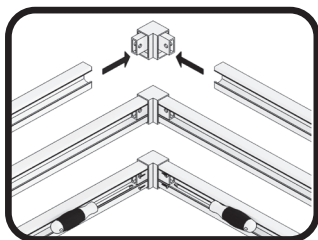

7

TALADRAR LA PARED CON BROCA DE 6MM.



RETIRAR CRISTALES FIJOS SI FUESE NECESARIO.

8

ATORNILLAR LOS VASOS SOPORTE GUÍA SUPERIOR A PARED.

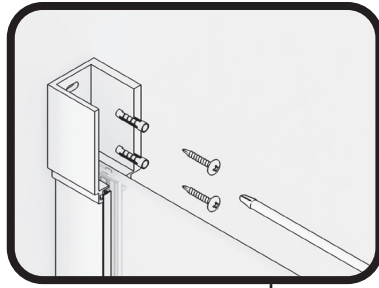

9

INTRODUCIR LOS DOS RODAMIENTOS Y EL TOPE FRENO TRASERO EN GUÍA SUPERIOR. CORTAR EL GUARDARRAIL AL ANCHO DEL HUECO OCUPADO POR LA PUERTA CORREDERA E INTRODUCIR EN LA GUÍA.

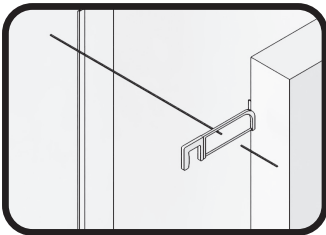
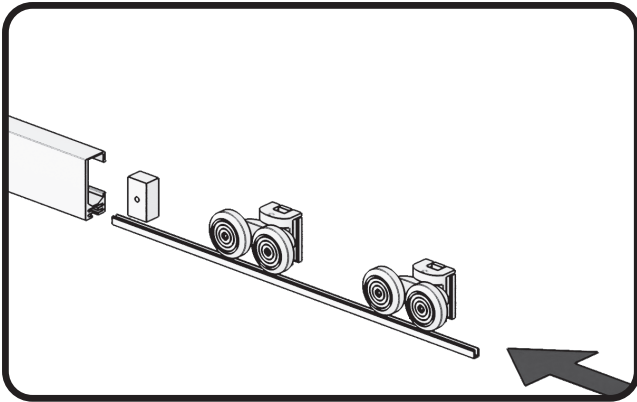

10

COLOCAR LA GUÍA SUPERIOR EN LOS VASOS COGIDA A PARED Y FIJAR LA COGIDA A LA GUÍA, MEDIANTE LOS TORNILLOS PRISIONEROS, CON LLAVE ALLEN.

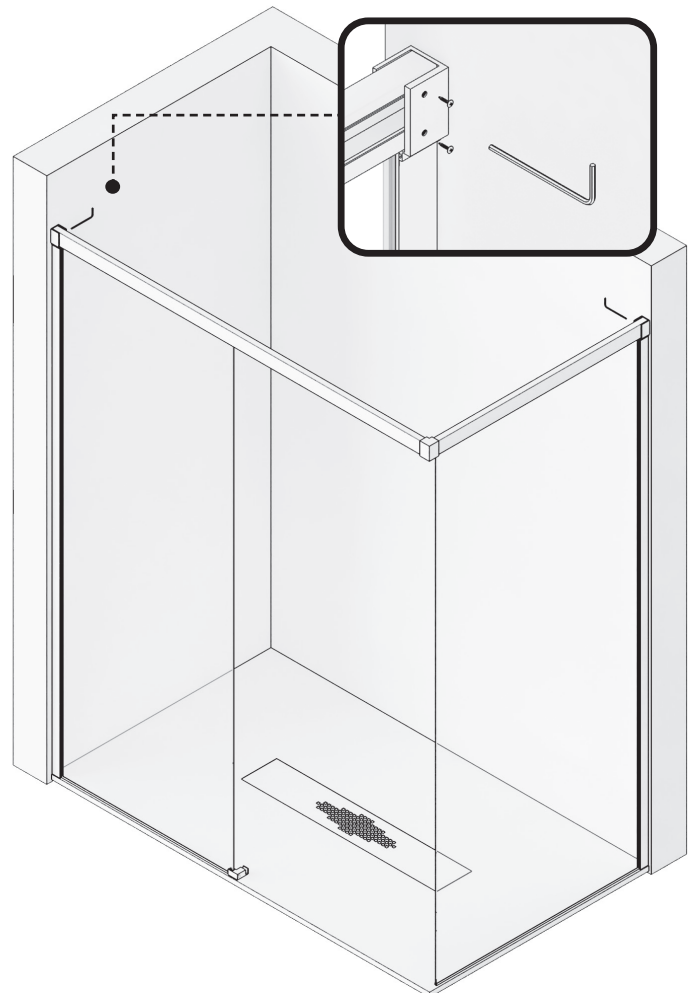

11

COLOCAR LA GOMA INFERIOR VIERTEAGUAS EN LA HOJA CORREDERA Y MONTARLA EN LOS RODAMIENTOS, INTRODUCIENDO LA MISMA EN LA PINZA GUIA INFERIOR. GRADUAR EN ALTURA Y NIVELAR, FIJÁNDOLA FUERTEMENTE EN SU POSICIÓN.

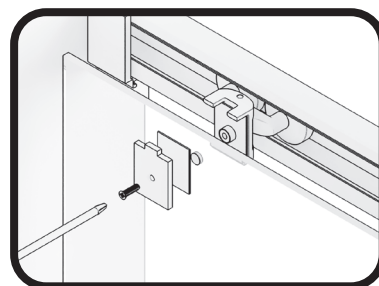
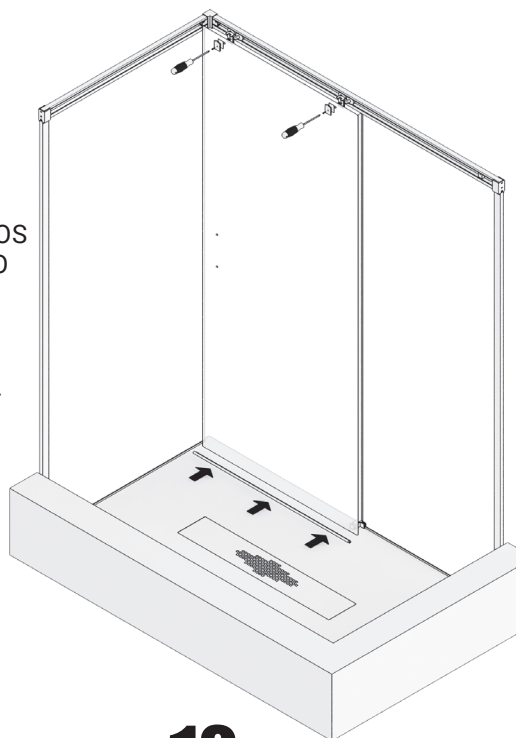

12

COLOCAMOS LAS GOMAS ALA DE CRUCE, UNA EN EL FIJO Y OTRA EN LA HOJA CORREDERA. COLOCAR EL ASA TIRADOR.

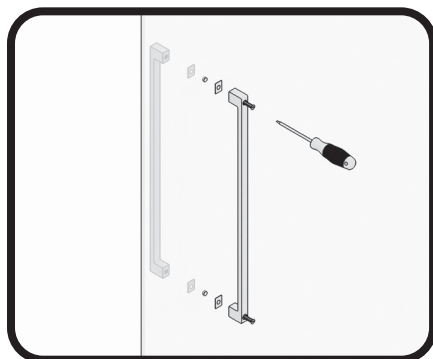
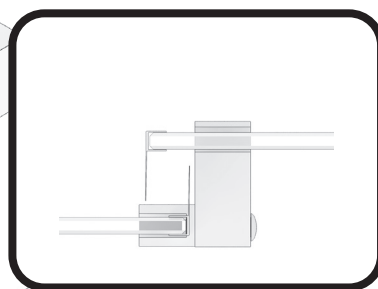

13

COLOCAR EL CIERRE GOMA IMAN FRONTAL EN EL CANTO EXTERIOR DE LA HOJA CORREDERA Y EL CIERRE GOMA IMÁN FRONTO-LATERAL EN EL CANTO DEL VIDRIO DEL LATERAL FIJO.

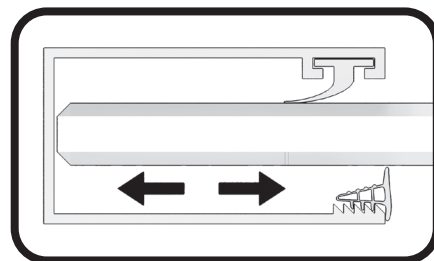

AJUSTAR EL JUEGO DE LOS VIDRIO FIJO SEGÚN NECESIDAD. FIJAR EL VIDRIO, ENGOMANDO EL CRISTAL CON EL PERFIL A PARED Y CON LA GUIA SUPERIOR.

14

FIJAR LOS TOPE FRENO EN SU POSICIÓN, MEDIANTE SU TORNILLO PRISIONERO.

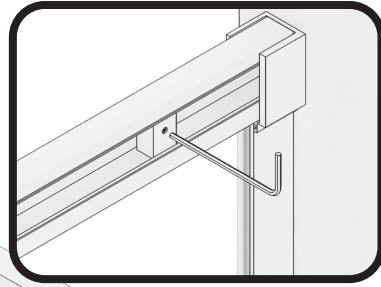

15

MEDIMOS, CORTAMOS, MONTAMOS SUS TAPONES Y PEGAMOS EL PERFIL DE ESTANQUEIDAD, DE PINZA INFERIOR AL LATERAL FIJO, POR DELANTE DE LA HOJA CORREDERA.

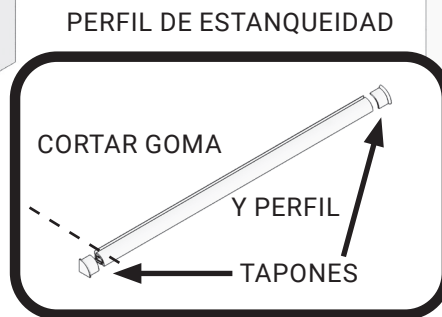





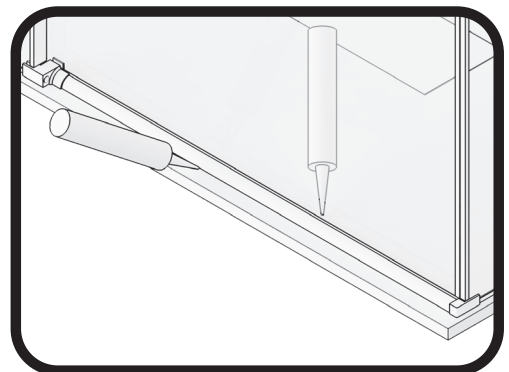



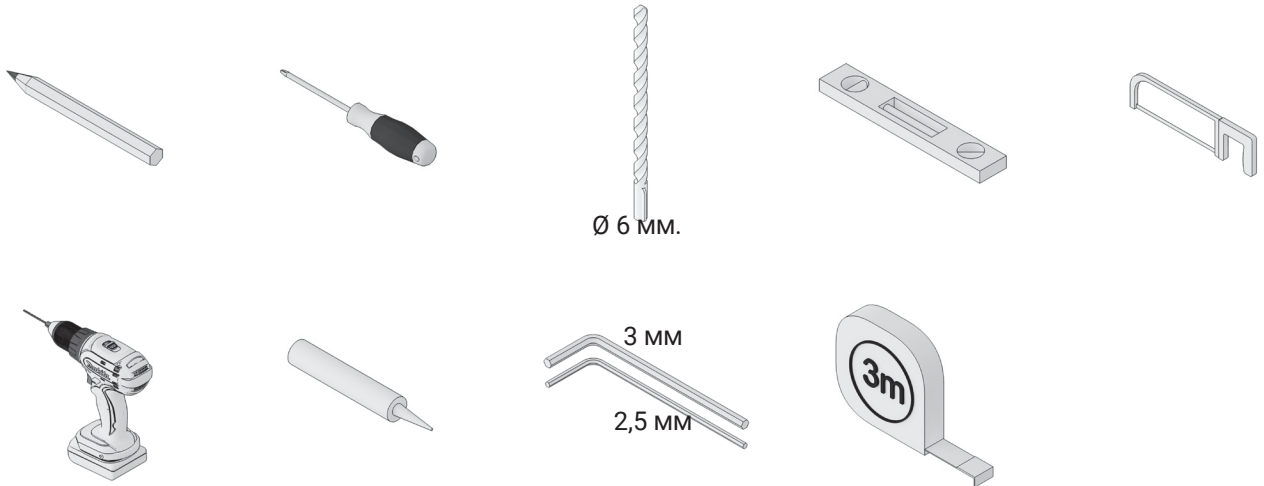

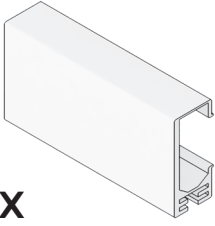
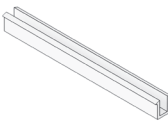
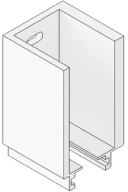
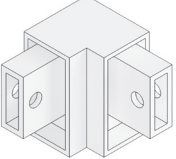
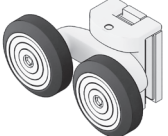

16

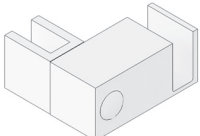
SELLAR CON SILICONA EL CONTORNO EXTERIOR DE LA MAMPARA.

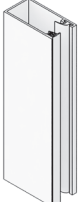
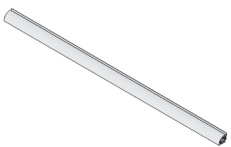

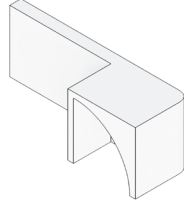
A3

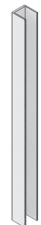

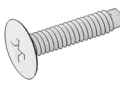
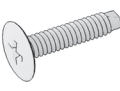
- | | | | | | |
|---|--|--|--|--|---|
| 2X

HOJA FIJA | 1X

HOJA CORREDERA | 2X

GUÍA SUPERIOR | 1X

VARILLA GUÍA SUPERIOR | 2X

VASO SOPORTE GUÍA | |
| 1X

CODO UNIÓN GUÍA | 2X

RODAMIENTO SUPERIOR DOBLE TAMDEN | 2X

TOPE FRENO | 1X

GUÍA PINZA INFERIOR | 1X

ASA TIRADOR | |
| 2X

PERFIL "U" FIJO A PARED | 1X

PERFIL DE ESTANQUEIDAD | 1X

TERMINAL PERFIL VIERTEGUAS | 1X

TERMINAL A FIJO PERFIL ESTANQUEIDAD | 1X

CIERRE IMAN FRONTO-LATERAL | |
| 1X

GOMA INFERIOR VIERTEGUAS PUERTA | 1X

GOMA ESTANQUEIDAD INFERIOR FIJO | 2X

GOMAS DE ALA CRUCE | 10X

TACOS N° 6 | 10X

TORNILLOS 4.2 X 32 | 4X

TORNILLOS AUTORROSCANTE 3.5 X 9.5 |

fabricación nacional